

COLONIST PINE GRAIN 6'-8"

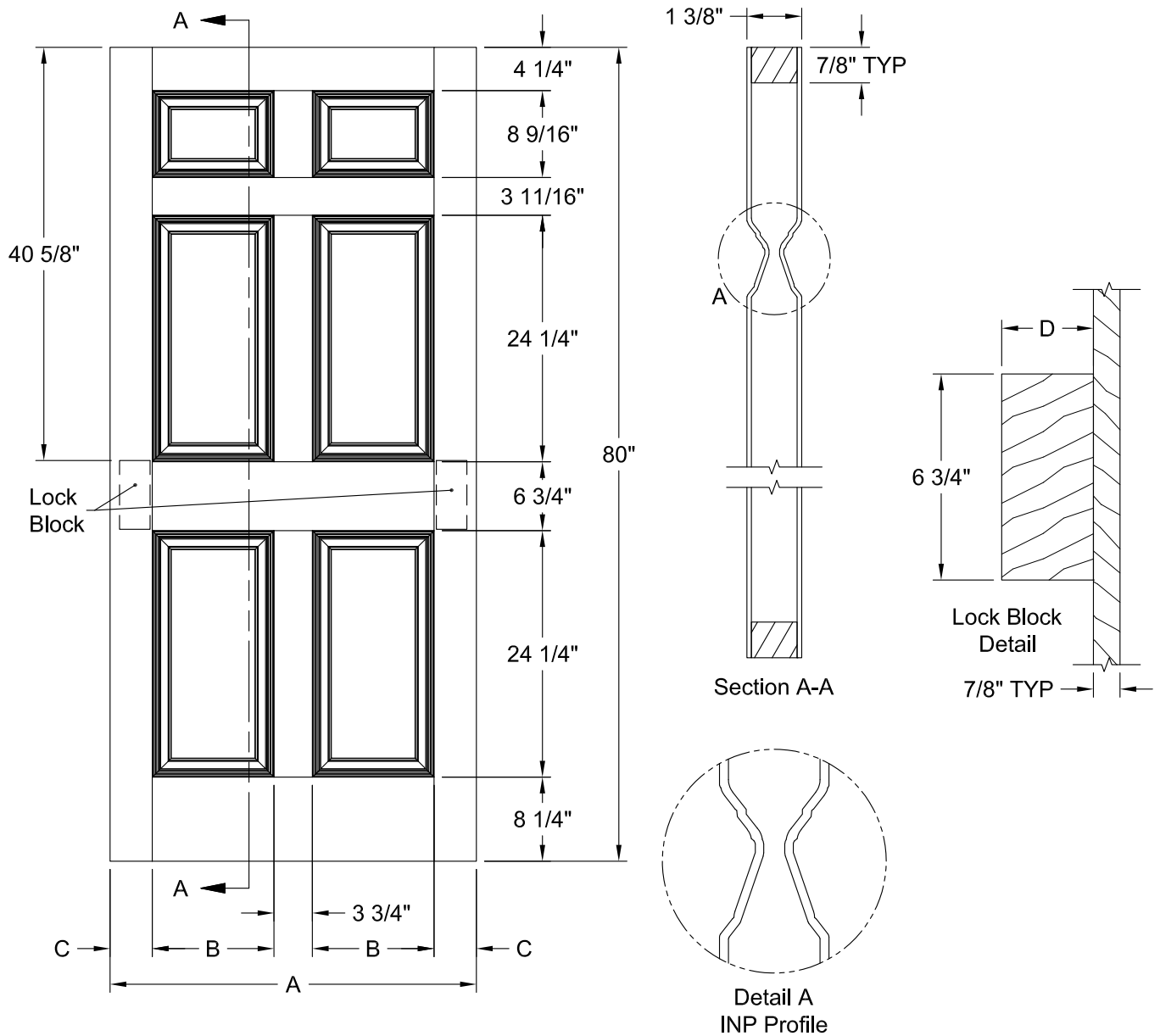

Dimension Table				
Door Size	A	B	C	D
3'-0" x 6'-8"	36"	12"	4 1/8"	3"
2'-10" x 6'-8"	34"	10"	5 1/8"	3"
2'-8" x 6'-8"	32"	10"	4 1/8"	3"
2'-6" x 6'-8"	30"	9"	4 1/8"	3"
2'-4" x 6'-8"	28"	8"	4 1/8"	3"
2'-2" x 6'-8"	26"	6"	5 1/8"	3"
2'-0" x 6'-8"	24"	6"	4 1/8"	3"
1'-10" x 6'-8"	22"	6"	3 1/8"	2 1/8"

COLONIST PINE GRAIN 6'-8"

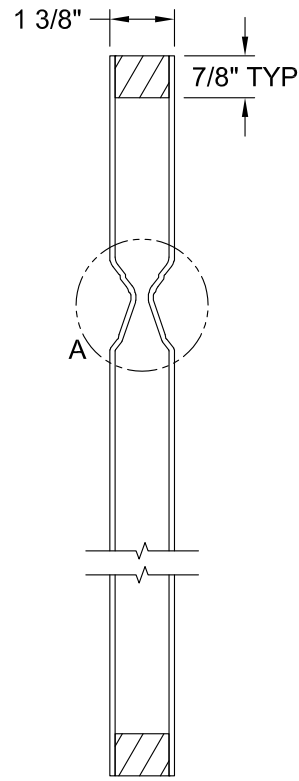
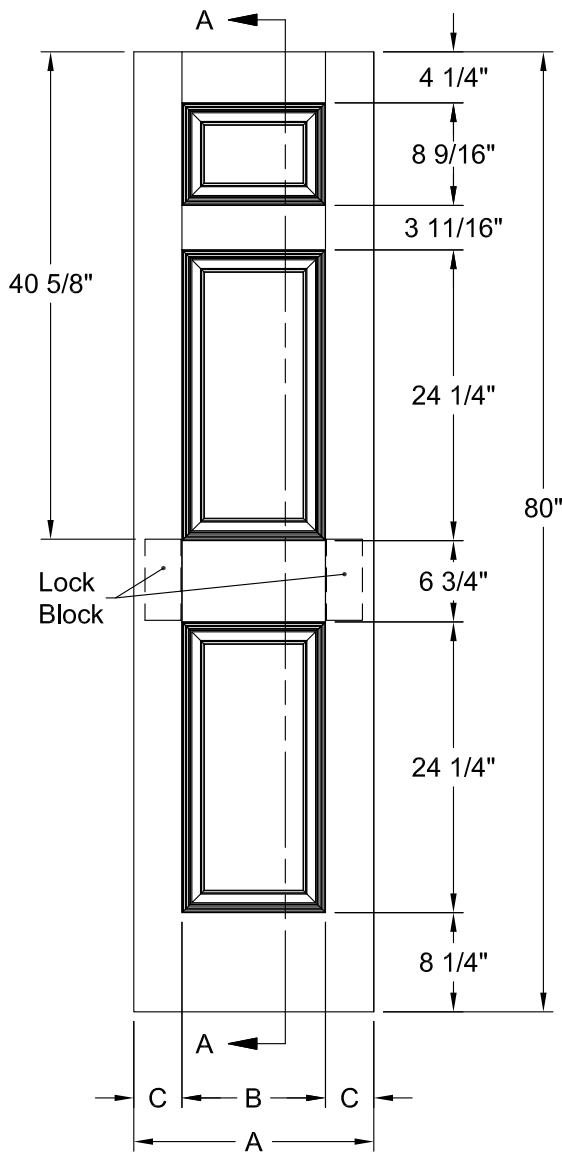

Section A-A

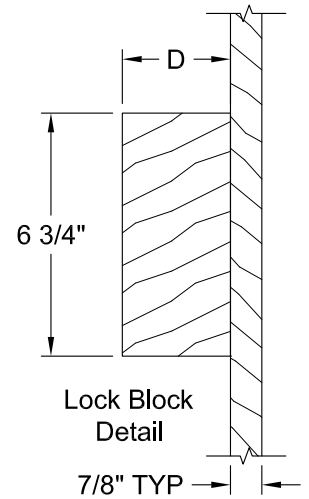

Lock Block Detail

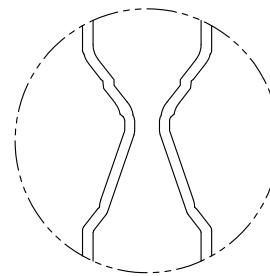

Detail A  
INP Profile

Dimension Table				
Door Size	A	B	C	D
1'-8" x 6'-8"	20"	12"	4"	3"
1'-6" x 6'-8"	18"	12"	3"	1 5/8"
1'-4" x 6'-8"	16"	7"	4 1/2"	3"
1'-3" x 6'-8"	15"	7"	4"	3"
1'-2" x 6'-8"	14"	7"	3 1/2"	2 1/8"
1'-0" x 6'-8"	12"	7"	2 1/2"	1 3/8"

COLONIST BIFOLD PINE GRAIN 6'-8"

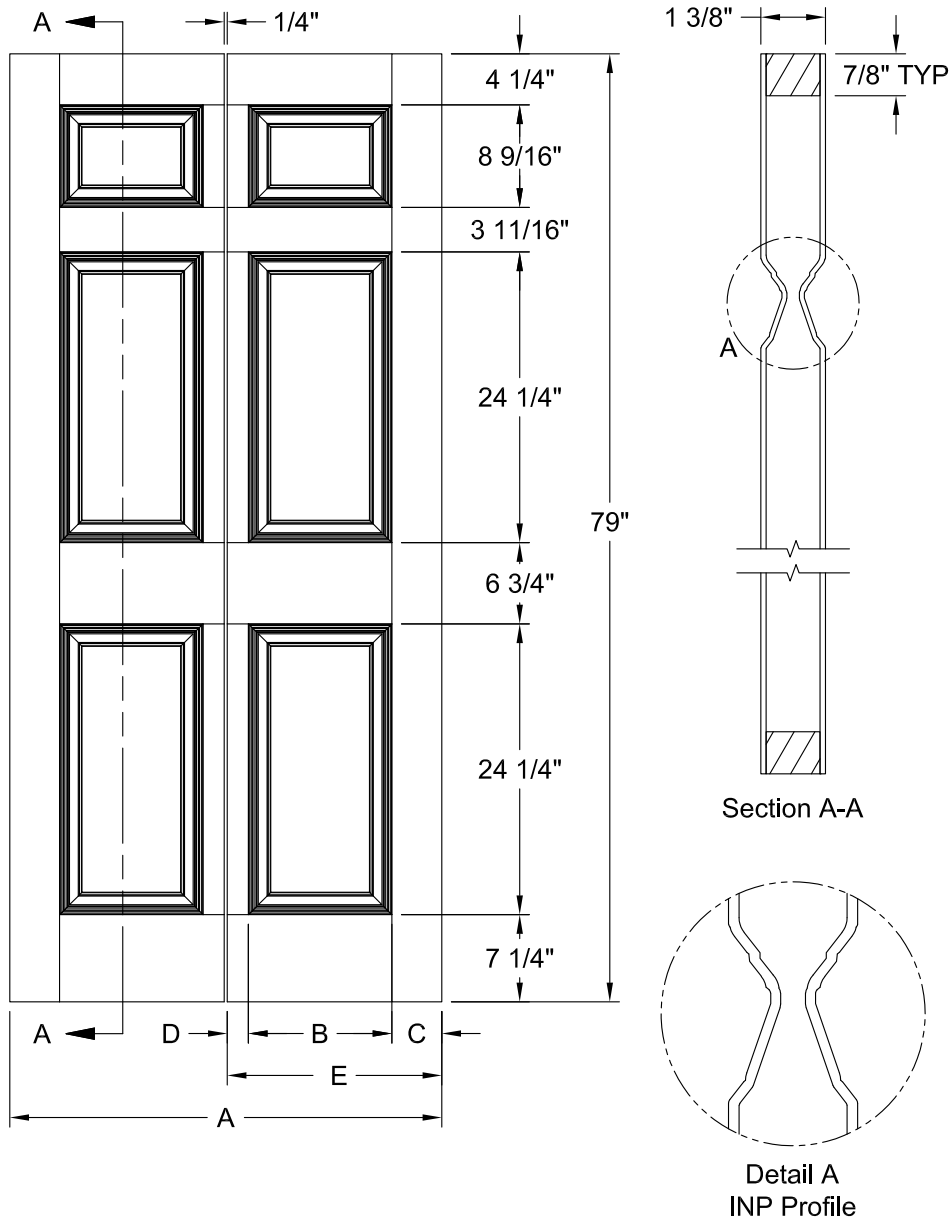

Dimension Table					
Door Size	A	B	C	D	E
3'-0" x 6'-8"	36"	12"	4 1/8"	1 3/4"	17 7/8"
2'-10" x 6'-8"	34"	10"	5 1/8"	1 3/4"	16 7/8"
2'-8" x 6'-8"	32"	10"	4 1/8"	1 3/4"	15 7/8"
2'-6" x 6'-8"	30"	9"	4 1/8"	1 3/4"	14 7/8"
2'-4" x 6'-8"	28"	8"	4 1/8"	1 3/4"	13 7/8"
2'-2" x 6'-8"	26"	6"	5 1/8"	1 3/4"	12 7/8"
2'-0" x 6'-8"	24"	6"	4 1/8"	1 3/4"	11 7/8"
1'-10" x 6'-8"	22"	6"	3 1/8"	1 3/4"	10 7/8"