

NOTE: DISTANCE FROM CENTER OF NEWEL HOLE TO CENTER OF RAIL VARIES CONTINUOUSLY ALONG THE LENGTH OF THE VOLUTE.

		
35280 Scio-Bowenston Road Bowerston, OH 44695-9731 Phone (740) 289-4111 FAX (740) 289-9047 <small>This drawing is the property of L.J. Smith Co. Do not use or copy without permission from L.J. Smith.</small>		
Drawing Name		
LJ-7B36		
Date	Scale	VEND Drawn By
04/15/10	DO NOT SCALE	BRR
File Name DESTROY PREVIOUS PRINTS		
LJ7B36		SALES



CONECT-A-KIT® ASSEMBLY INSTRUCTIONS

Conect-A-Kit® Patent No. 5,261,201

READ THIS ENTIRE ASSEMBLY GUIDE BEFORE BEGINNING!

Shown here are the various types of assembly connections that may be encountered using the Conect-A-Kit® fitting components. Each connection lists the steps to be used. All steps on this assembly instruction sheet are to be performed in sequence. This guide is to be used in conjunction with the L.J. Smith Balustrade Installation Guide (LJ-0694 INST).

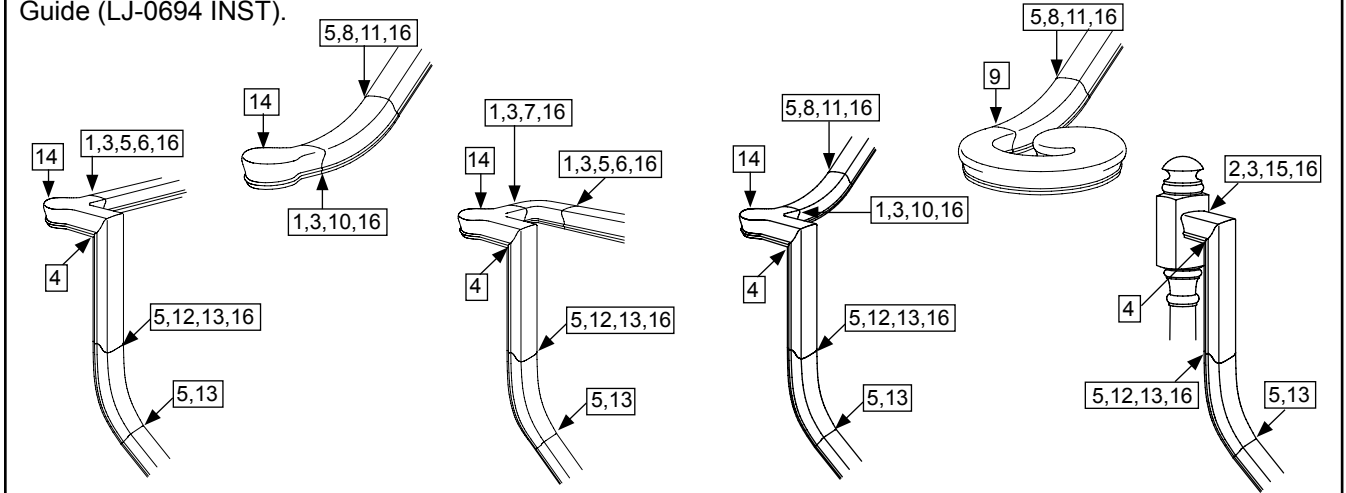

NOTE: Do NOT remove any top lids until ALL trim cuts have been made. Bottom caps and filler pieces MUST be in place in the easings with ends flush when trim cuts are made. Do NOT apply glue to the top lids, bottom caps or bottom filler pieces until all connections are aligned and tightened.

Step 1 - Square Cut 45 Degree Ends. (Figure A)

Most Conect-A-Kit® fittings are provided with 45 degree mitered ends for easy assembly to rail drops. Assembly to any other item requires square cutting of the mitered end. Trim the mitered end using a miter saw. Use the bottom edge of the miter as a guide.

Helpful Hint: For fittings with a cap, place a 5/8" spacer between the fitting and the miter saw fence to help ensure a square cut.

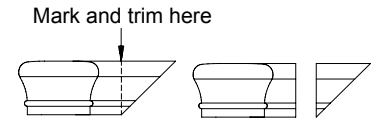

Figure A

Step 2 - Square Cut Returned End. (Figure B)

In order to assemble a returned end to a post to post newel, the returned end must be square cut. Trim the returned end using a miter saw. Measure 2 5/8" from the bottom edge of the miter. This measurement will give you the maximum length on the returned end. If your landing newel is positioned further back than the face of the top riser, you might need to add additional straight rail to the returned end.

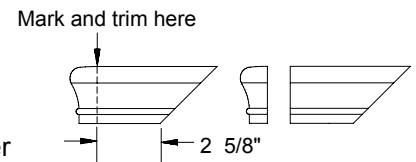

Figure B

Step 3 - Remove Top Lids. (Figure C)

DO NOT REMOVE THE TOP LID ON ANY FITTING UNTIL ALL TRIM CUTS HAVE BEEN MADE. Carefully remove the top lid of the fitting by using a 1" to 1 1/2" putty knife or chisel to pry it off.

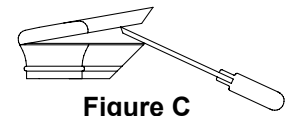

Figure C

Step 4 - Assemble 45 Degree Miter to Rail Drop. (Figure D)

Use a 5/16" x 2" lag bolt to assemble the 45 degree mitered fitting to the rail drop. To tighten the lag bolt, use our LJ-3044 VersaTool™, a 1/2", 12-point, box-end wrench or a 1/2" socket. Use LJ-3020 Wood Glue syringe or carpenter's glue on all contact surfaces.

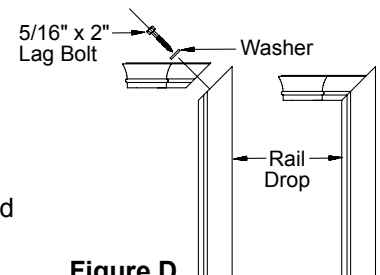
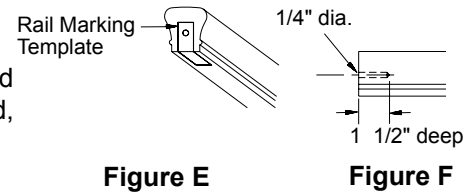

Figure D

Step 5 - Drill Pilot Hole. (Figures E and F)

A pilot hole must be drilled in any non-Conect-A-Kit® item except a volute or turnout (handrail, rail drop, overeasing, coped end) prior to assembly. Use the Rail Marking Template provided, or our LJ-3044 VersaTool™, to mark the centerpoint of the pilot hole (fig. E).

Drill a 1/4" diameter hole 1 1/2" deep (fig. F).



Step 6 - Assemble Level Conect-A-Kit® Fitting to Handrail. (Figure G)

Use a 5/16" x 2 1/2" lag bolt to assemble a level Conect-A-Kit® Fitting to Handrail. To tighten the lag bolt, use our LJ-3044 VersaTool™, or a 1/2", 12-point, box-end wrench. Use LJ-3020 Wood Glue syringe or carpenter's glue on all contact surfaces.

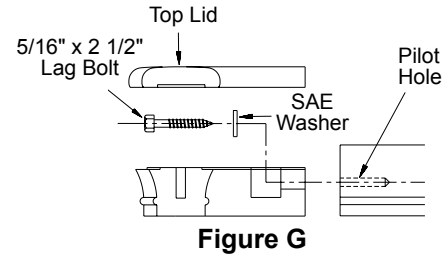

Step 7 - Assemble Conect-A-Kit® Fitting to Conect-A-Kit® Fitting. (Figure H)

Use a 5/16" x 2 1/4" machine bolt to assemble a Conect-A-Kit® item to any other Conect-A-Kit® item. Use the 3/8" SAE washer on the bolt head end, and the 3/8" SAE washer and the 5/16" lock washer on the nut end. Use this method when assembling a level horseshoe assembly, or any Conect-A-Kit® to Conect-A-Kit® assembly. To tighten the bolt, use the LJ-3044 VersaTool™, or a 1/2", 12-point, box-end wrench. Tighten by using the wrench on the bolt end. Use LJ-3020 Wood Glue syringe or carpenter's glue on all contact surfaces.

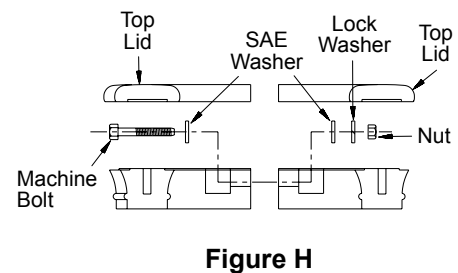

Step 8 - Trim Easing at Lower End of Flight. (Figures I, J, and K)

Easings must be trimmed to the pitch of the stair. **DO NOT REMOVE THE BOTTOM CAP OR FILLER PIECE UNTIL THE EASING HAS BEEN TRIMMED. FOR PLOWED EASINGS, BE SURE THE BOTTOM FILLER PIECE IS IN PLACE AND THE END THAT WILL NOT BE TRIMMED IS FLUSH BEFORE TRIMMING.** Always trim the end of the easing which is stamped "CUT THIS END" or the end that does not have a machined slot. If the fitting has machined slots on both ends and is not marked with the stamp, push a screwdriver in the slots and cut the end that allows the screwdriver to go in the deepest. Mark the tangent point on the easing using the pitchblock (Fig. I). Mark the cut line on the easing using the pitchblock (Fig. J). Trim the easing on a miter saw while using the pitchblock as support (Fig. K).

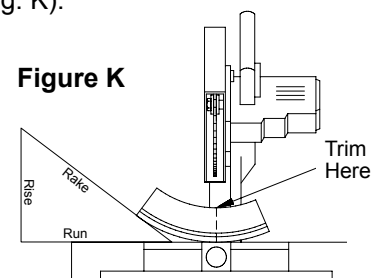
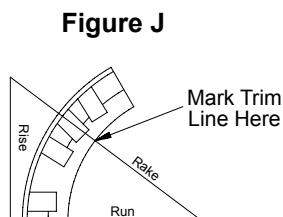
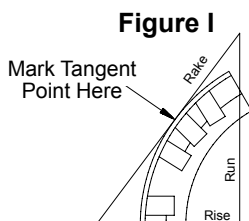

Step 9 - Assemble Easing to Non-Conect-A-Kit® Fitting.

(Figure L)

Remove the bottom filler piece from the easing. For solid bottom easings, use a 1" putty knife or chisel and carefully remove the bottom cap piece from the easing. Use a 5/16" x 2" lag bolt to assemble the single pocket end of the easing to a non-Conect-A-Kit® fitting (turnout, volute, handrail, overeasing, coped end). To tighten the lag bolt, use our LJ-3044 VersaTool™, a 1/2", 12-point, box-end wrench or a 1/2" socket. Use LJ-3020 Wood Glue syringe or carpenter's glue on all contact surfaces.

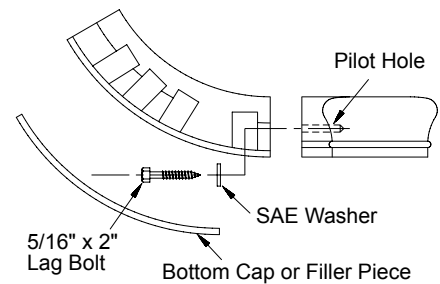

Figure L

Step 10 - Assemble Easing to Conect-A-Kit® Fitting. (Figure M)

Remove the bottom filler piece from the easing. For solid bottom easings, use a 1" putty knife or chisel and carefully remove the bottom cap piece from the easing. Use a 5/16" x 2 1/4" machine bolt to assemble the single pocket end of the easing to any Conect-A-Kit® item. Use the 3/8" SAE washer on the bolt head end, and the 3/8" SAE washer and the 5/16" lock washer on the nut end. To tighten the lag bolt, use our LJ-3044 VersaTool™, or a 1/2", 12-point, box-end wrench. Use LJ-3020 Wood Glue syringe or carpenter's glue on all contact surfaces.

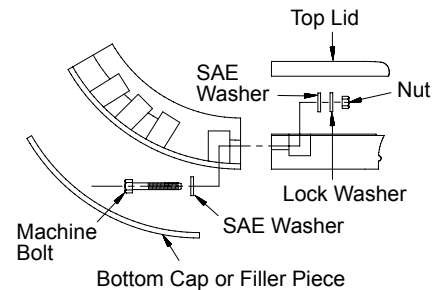

Figure M

Step 11 - Assemble Easing at Lower End of Flight to Handrail. (Figure N)

(Figure N)

Drill a pilot hole in the handrail as described in step 5. Use a 5/16" x 3 1/2" lag bolt to assemble the trimmed end of the easing to the handrail. To tighten the lag bolt, use our LJ-3044 VersaTool™, or a 1/2", 12-point, box-end wrench. Use LJ-3020 Wood Glue syringe or carpenter's glue on all contact surfaces.

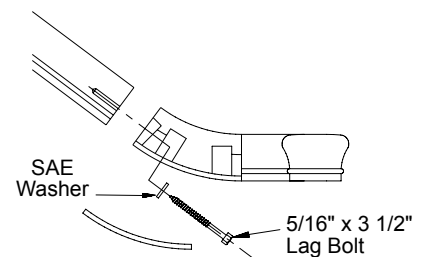

Figure N

Step 12 - Trim Easing at Upper End of Flight. (Figures O, P, and Q)

Easings must be trimmed to the pitch of the stair. **DO NOT REMOVE THE BOTTOM CAP OR FILLER PIECE UNTIL THE EASING HAS BEEN TRIMMED.** FOR PLOWED EASINGS, BE SURE THE BOTTOM FILLER PIECE IS IN PLACE AND THE END THAT WILL NOT BE TRIMMED IS FLUSH BEFORE TRIMMING. Always trim the end of the easing which is stamped "CUT THIS END" or the end that does not have a machined slot. If the fitting has machined slots on both ends and is not marked with the stamp, push a screwdriver in the slots and cut the end that allows the screwdriver to go in the deepest. Mark the tangent point on the easing and mark the cut line on the easing using the pitchblock (Fig. O). Trim the easing on a miter saw while using the pitchblock as a prop (Fig. P). Remove the bottom filler from the easing. For solid bottom easings, use a 1" putty knife or chisel and carefully remove the bottom cap piece from the easing. Following Step 77 in the L.J. Smith Balustrade Installation Guide, locate the easing tangent to the rail drop and the handrail. Use a torpedo level to ensure proper location. Mark and trim the rail drop and handrail as shown (Fig. Q).

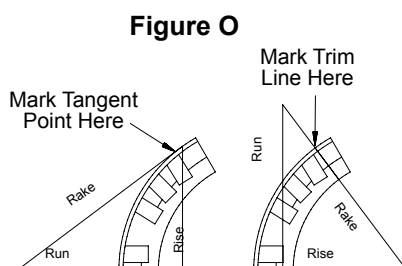

Figure O

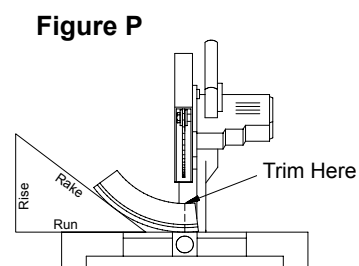

Figure P

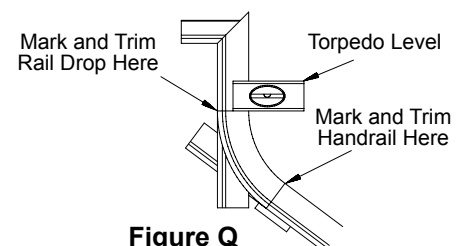
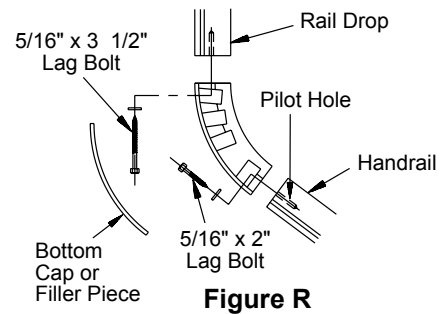

Figure Q

Step 13 - Assemble Easing at Upper End of Flight to Handrail and Rail Drop. (Figure R)

Drill pilot holes in the handrail and the rail drop as described in Step 5. With the bottom cap or filler piece removed from the easing, use a 5/16" x 2" lag bolt to assemble the untrimmed end of the easing to the handrail. Use a 5/16" x 3 1/2" lag bolt to assemble the trimmed end of the easing to the rail drop. To tighten the lag bolt, use our LJ-3044 VersaTool™, or a 1/2", 12-point, box-end wrench. Use LJ-3020 Wood Glue syringe or carpenter's glue on all contact surfaces.



Step 14 - Fasten Fitting to Over the Post Newel. (Figure S)

Use a 5/16" x 2" lag bolt to fasten a Conect-A-Kit® fitting to an over the post newel. Drill a 9/32" diameter x 1 1/2" deep pilot hole in the top of the newel. Use a 1/2" socket wrench to tighten the lag bolt. Use LJ-3020 Wood Glue syringe or carpenter's glue on all contact surfaces.

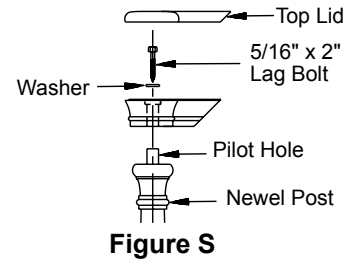

Step 15 - Fasten Fitting to Post to Post Newel. (Figure T)

Drill a 1/4" diameter x 1 1/2" deep pilot hole into the face of the square top newel. Locate this hole so that it will line up with the center of the slot in the trimmed returned end. Fasten using a 5/16" x 2" lag bolt. To tighten the lag bolt, use our LJ-3044 VersaTool™, or a 1/2", 12-point, box-end wrench. Use LJ-3020 Wood Glue syringe or carpenter's glue on all contact surfaces.

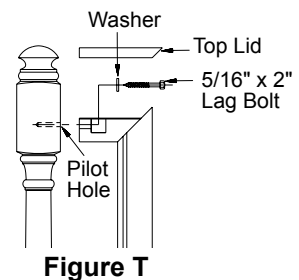

Step 16 - Assemble Top Lids, Bottom Caps and Filler Pieces. (Figure U)

Following assembly of the entire system, assemble all Conect-A-Kit® top lids and bottom caps or filler pieces using LJ-3020 Wood Glue syringe or carpenter's glue and clamps. It is only necessary to apply a small amount of glue around the stepped-down edge on the machined half of the fitting. It is important that any excess glue be removed with a damp cloth prior to finishing, as this may cause uneven staining. It is also important that all glue joints have an opportunity to cure before any sanding is done.

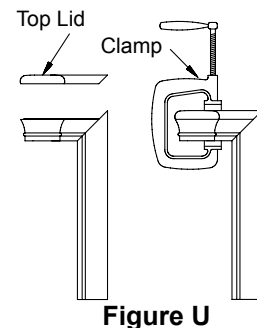

Fitting Hardware Uses:

- 5/16" x 2" Lag Bolt:** Attach a Conect-A-Kit® fitting to a newel.
Attach Rail Drop to a 45 degree miter.
Attach untrimmed end of an Easing to handrail.
Attach untrimmed end of an Easing to a non-Conect-A-Kit® starting fitting.
- 5/16" x 2 1/2" Lag Bolt:** Attach the square cut end of a Conect-A-Kit® fitting to handrail.
- 5/16" x 3 1/2" Lag Bolt:** Attach the trimmed end of an Easing to handrail or rail drop.
- 5/16"-18 x 2 1/4" Machine Bolt:** Attach Conect-A-Kit® fitting to Conect-A-Kit® fitting.
- 5/16"-18 Hex Nut:** Use with the Machine Bolt.
- 3/8" SAE Flat Washer:** Use with a Lag Bolt.
- 5/16" Lock Washer:** Use with the Machine Bolt on the threaded end.
- Rail Bolt Pack:** Attach non-Conect-A-Kit® fitting to non-Conect-A-Kit® item.